

CARTON FLOW

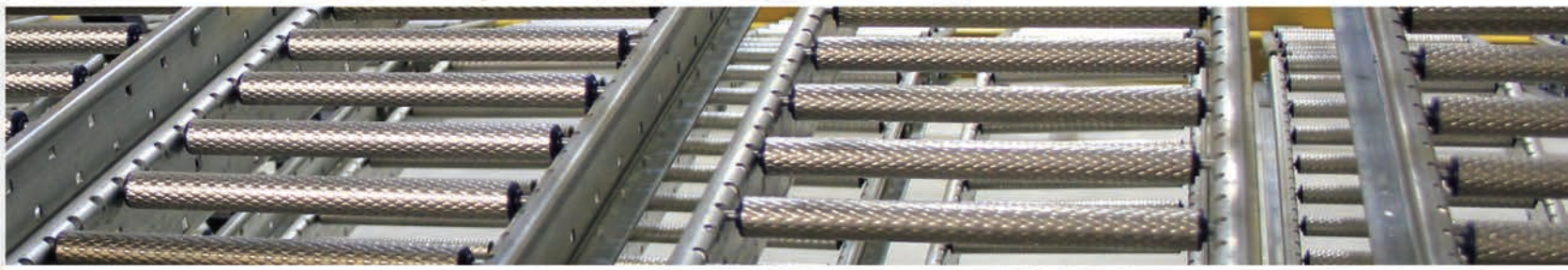

PALLET FLOW



PRODUCT CATALOG

Concentric System Benefits

Dura-Flex™ & Dura-Flo™ Systems

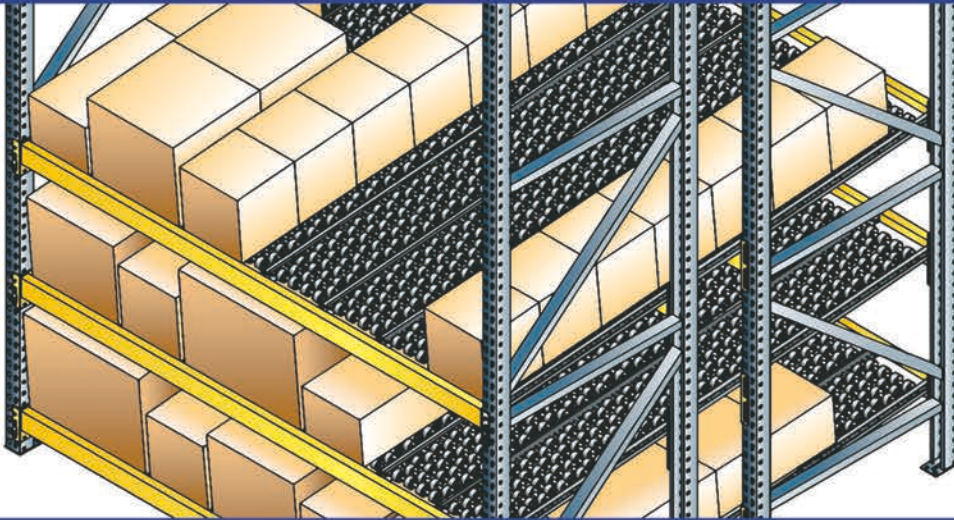

RhinoTrac™ Systems



Pallet Flow Systems

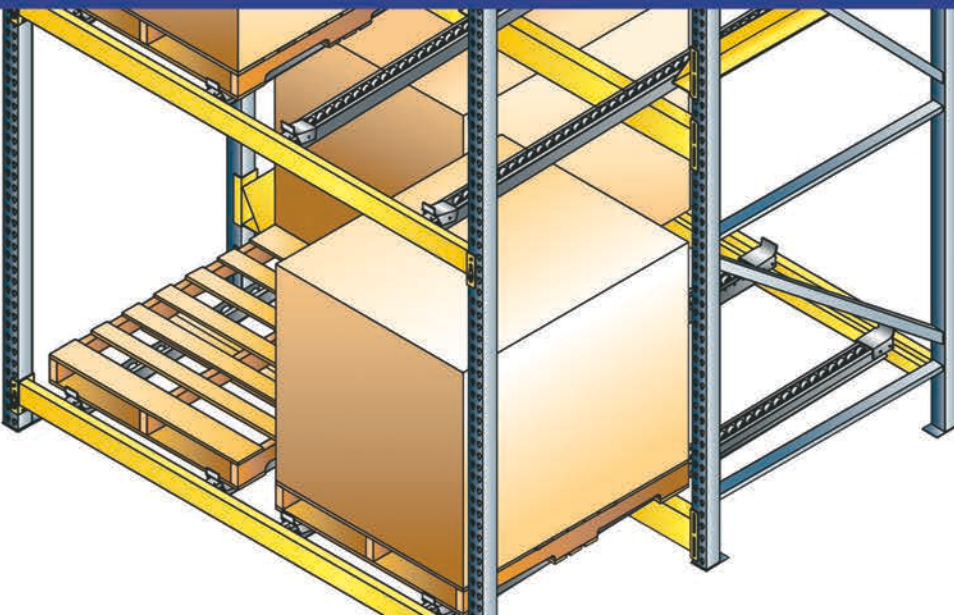

DURA-FLEX, DURA-FLO AND D2 CARTON FLOW PRODUCTS

- Full-bed of rollers for carton size flexibility
- Dura-Flex™ and Dura-Flo™ drop into structural or roll-formed pallet rack
- Dura-Flo D2™ fits any manufacturers' carton flow shelves
- Easy installation – no tools required

RHINOTRAC AND RHINODECK CARTON FLOW PRODUCTS

- Full-width aluminum rollers in pre-assembled lanes
- RhinoTrac™ drops into structural or roll-formed pallet rack
- RhinoDeck™ fits any manufacturers' carton flow shelves
- Easy installation – no tools required

CSS PALLET FLOW SYSTEMS

- Full range of products available for any weight or size pallet
- Polycarbonate resin plastic wheels or metal skate wheels
- Pallet braking systems for deep-lane pallet flow
- Wide-Roller option for full-width pallet support

●	CARTON FLOW OVERVIEW	4-5
●	DURA-FLEX™ & DURA-FLO™ HEAVY-DUTY CARTON FLOW	6-7
	Carton Flow System Specifications	
●	DURA-FLO™ D2 CARTON FLOW LOW-PROFILE HEAVY-DUTY	8-9
	Carton Flow System Specifications	
●	RHINOTRAC CARTON FLOW HEAVY-DUTY	10-11
	Carton Flow System Specifications Options	
●	RHINODECK CARTON FLOW LOW-PROFILE HEAVY-DUTY	12-13
	Carton Flow System Specifications	
●	CARTON FLOW OPTIONS	14-15
●	PALLET FLOW	16-19
	Pallet Flow System Specifications Wide-Roller Pallet Flow Braking Systems	



Carton Flow Product Overview

- More cartons - Low profile shelves
- More surface support - Solid bed or full-width
- Less maintenance - Heavy-duty side channels & axles
- All carton flow products drop in with no tools required

Carton Flow Options Comparison

DURA-FLEX™ & DURA-FLO™

DURA-FLO and D2

- Continuous bed of rollers
- Accommodates any mix of carton sizes
- Available in 12" and 16" wide lanes
- Rollers can be spaced on 2", 3" or 4" centers

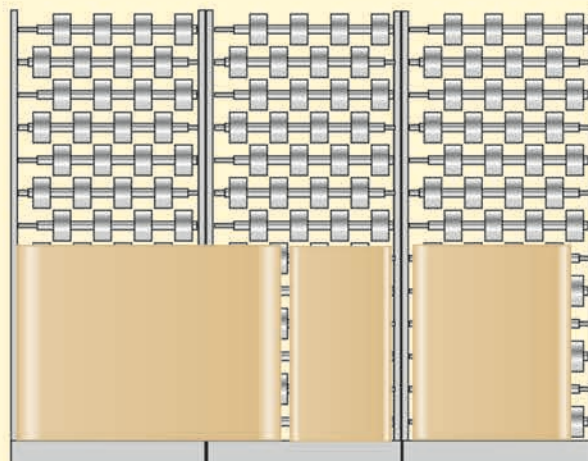
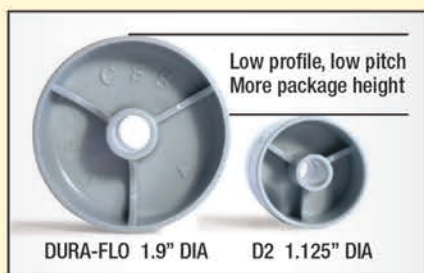

Full-bed of rollers provide maximum space utilization with no wasted space even when carton sizes change.

RHINO TRAC™

RHINO TRAC and RHINO DECK

- Separately defined lanes for flow
- Roller widths are available in 6", 9", 12" and 15"
- Rollers can be spaced on 1", 2" or 3" centers



RHINO TRAC & RHINO DECK
0.75" Dia. Aluminum Rollers

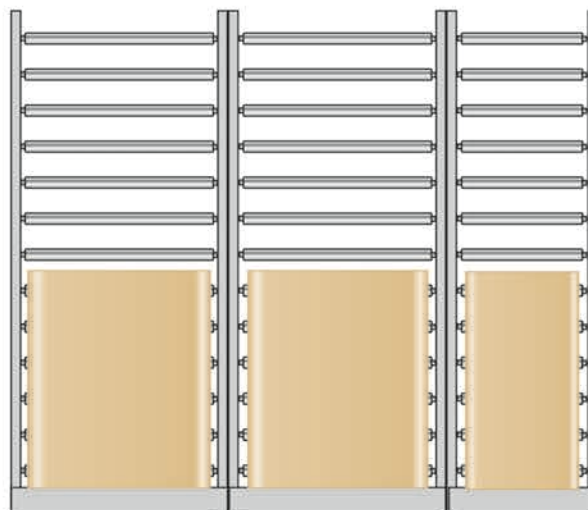



CONCENTRIC STORAGE SYSTEMS

COMPATIBLE WITH ALL MAJOR PALLET RACK BRANDS



DURA-FLEX™ DURA-FLO™

- 1.9" diameter plastic wheels
- 1" wide flow surface
- 2.13" high galvanized steel side channel
- Fits any pallet rack, new or retrofit



DURA-FLO™ D2

- 1.125" diameter plastic wheels
- 1.4" wide flow surface
- 1.125" high galvanized steel side channel
- Fits any carton flow, new or retrofit



RHINO TRAC™

- 0.75 diameter aluminum rollers
- 6", 9", 12" or 15" wide rollers
- 2.5" high galvanized steel side channels
- Fits any pallet rack, new or retrofit



RHINO DECK™

- 0.75 diameter aluminum rollers
- 6", 9", 12" or 15" wide rollers
- 1.1" high galvanized steel side channels
- Fits any carton flow, new or retrofit

Traditional carton flow systems utilize individual tracks, which are difficult to install and result in maintenance issues and hangups, causing picking inefficiencies.



REPLACE & UPGRADE

Convert any existing pallet racking or carton flow shelving unit into a brand new carton flow system by simply dropping in pre-assembled lanes of DURA-FLEX, DURA-FLO or RHINO TRAC

Reduce pick costs with more reliable flow and less hang-ups

Improved inventory control, no product falling between tracks

DURA-FLEX & DURA-FLO

SUPERIOR CARTON FLOW SYSTEMS

- More cartons
- More surface support
- More slotting flexibility

DURA-FLEX & DURA-FLO pre-assembled carton flow lanes drop into pallet rack.

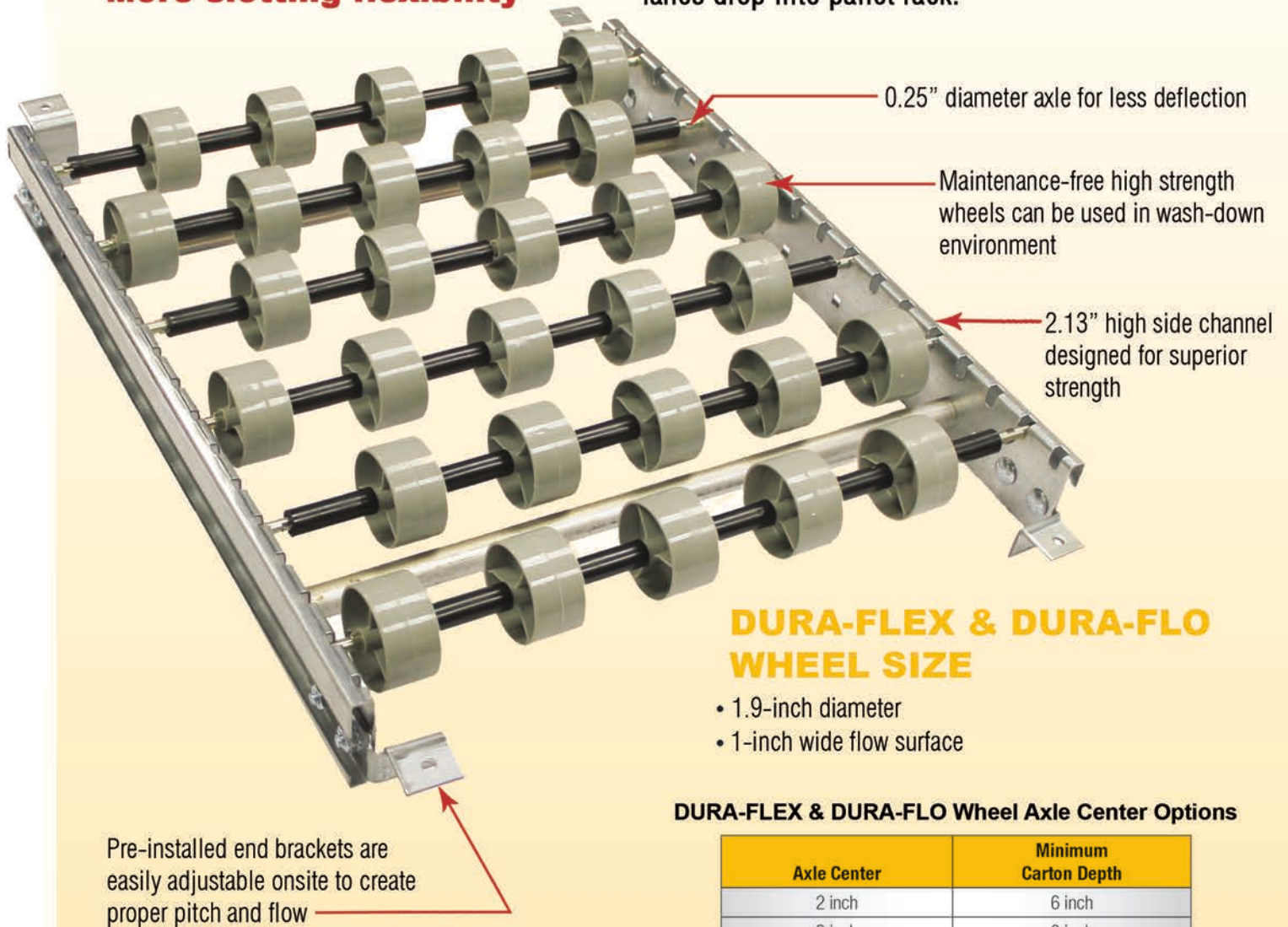

DURA-FLEX & DURA-FLO WHEEL SIZE

- 1.9-inch diameter
- 1-inch wide flow surface

DURA-FLEX & DURA-FLO Wheel Axle Center Options

Axle Center	Minimum Carton Depth
2 inch	6 inch
3 inch	9 inch
4 inch	12 inch



DURA-FLEX ROLL-FORMED BEAM MOUNT



Pre-installed brackets adjust easily onsite for perfect fit for proper flow.

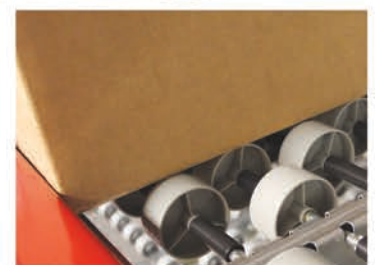

Adjustable end bracket rests in step of beam to allow beam to act as box stop.

DURA-FLEX™ & DURA-FLO™ Carton Flow SPECIFICATIONS



Lane Indexers are easy to reposition.

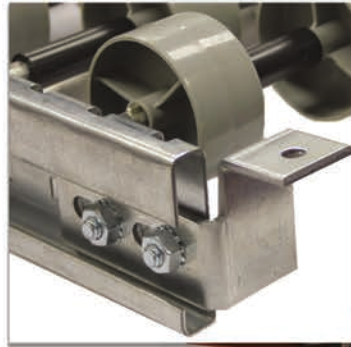

DURA-FLEX end brackets have slotted adjustability to zero-in on the perfect length so tracks fit correctly in any installation.

DURA-FLEX and DURA-FLO Carton Flow System Options and Accessories

- Lane indexers
- Cantilevered high-mount extension
- Low-mount & high-mount applications
- Forward tilt shelf
- High-mount rear extension
- Splice plates for custom lengths
- Attach to beams with beam hangers



Contiguous wheel span creates a deck for mixed package width on the same shelf, maximizing space and efficiency.

12" DURA-FLEX

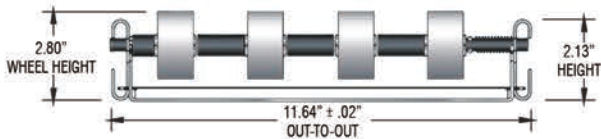

16" DURA-FLEX

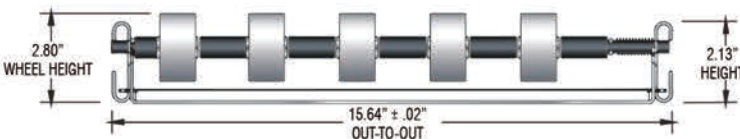

**Note: Dura-Flo Side Channel Height = 2.28" High and Wheel Height = 2.50" High
Dura-Flo 12" Lanes = 11.86" Out-To-Out and 16" Lanes = 15.80" Out-to-Out

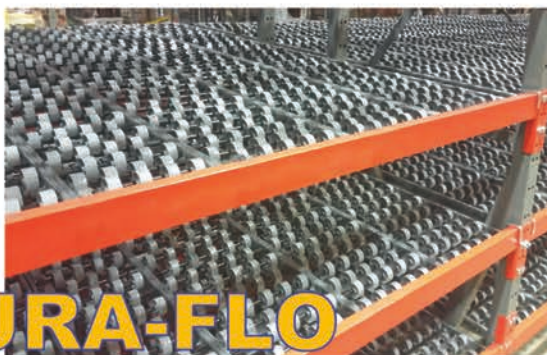

DURA-FLO ROLL-FORMED BEAM MOUNT



DISCHARGE END
End bracket rests in step of beam to allow beam to act as box stop.



CHARGE END
Heavy-duty end bracket rests in step of beam and adjusts incrementally.

DURA-FLEX Carton Flow System Capacities (lbs. per sq. ft.)

Unsupported Span (in.)	Capacity	
	12 inch width	16 inch width
60	52	52
72	52	52
90	46	35
96	38	28
102	32	24
108	27	20
114	23	17

18 Gauge Channel Standard

** DURA-FLEX maximum capacity of 52 lbs. per sq. ft. governed by axle capacity.

DURA-FLO Carton Flow System Capacities (lbs. per sq. ft.)

Unsupported Span (in.)	Capacity	
	12 inch width	16 inch width
60	87	66
72	61	46
90	39	29
96	32	24
102	28	21
108	23	17
114	20	15

18 Gauge Channel Standard

DURA-FLO™ D2

DURA-FLO D2 LOW-PROFILE CARTON FLOW SYSTEMS

Dura-Flo D2 Low-Profile Carton Flow System, modeled after the original Dura-Flo system that creates a “bed of wheels” for fast, flexible carton flow. D2 features a low-profile, low-pitch design requiring no more than a drop of one inch per foot. Heavy-duty construction provides more than twice the load capacity of standard carton flow tracks and D2 easily drops right into your existing shelf structures.

Compact Size With Full Size Performance

Patented maintenance-free, 1.125 inch wheels with self-lubricating axles for smooth flow with virtually no hang ups.

Pre-assembled, drop-in shelves fit most existing carton flow beams for simple installation without tools.

Adjustable entry and exit brackets mount into beam connectors with no loss of vertical clearance. Ideal for pick to light systems and will not interfere with existing labeling.

Wide variety of options, including extension feet attachments for mounting to any manufacturers' carton flow shelves.

Heavy-duty, hardened steel axles. No tools required – just snap axles into place.

18-gauge specially designed “C” channel provides superior strength.

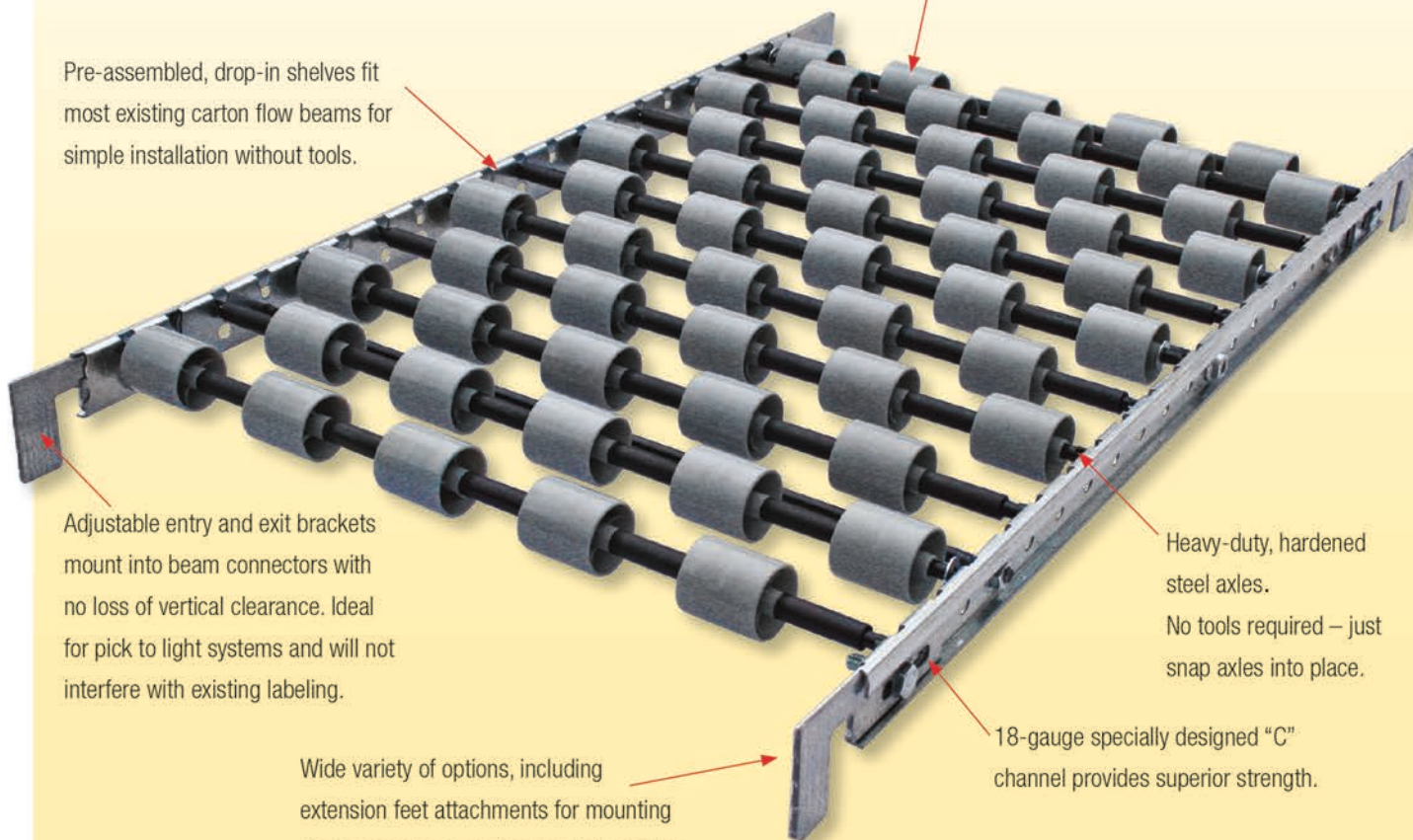

Full “bed of wheels” for superior carton flow



Twice the wheel coverage of traditional carton flow tracks for virtually no hang-ups.

D2 ADVANTAGE

No stop required, no loss of shelf clearance.



Easily replace wheel assemblies, just drop in new axle.

Dura-Flo™ D2 Carton Flow SPECIFICATIONS



Lane indexers are easy to reposition.

Superior tracking eliminates the need for full-length dividers.



EASY RETROFIT

Use with carton flow shelves and drop in Dura-Flo D2 lanes for improved warehouse space utilization.

Dura-Flo Wheel Axle Center Options

Axle Center	Minimum Carton Depth
2 inch	6 inch
3 inch	9 inch
4 inch	12 inch

Dura-Flo D2 Wheel Size

- 1.125" Diameter Wheel
- 1.4" Wide Surface

Track Profile

- 1.125" Steel side channel
- 1.375" Overall track height

Carton Requirements

- Subject to weight and length limits
- Not suitable for cartons with raised "lip" around outer edge

Carton Flow System Capacities (lbs. per sq. ft.)

Load capacity is determined by the capacity of the shelf. Carton flow shelves offering support at a minimum of 24" centers will have in excess of 50 lbs. per square foot capacity. Axles and wheels are rated at a higher capacity than side channels. Dura-Flo D2's heavy-duty design will hold up to busy picking operations, and eliminate the need for constant plastic wheel track replacement.

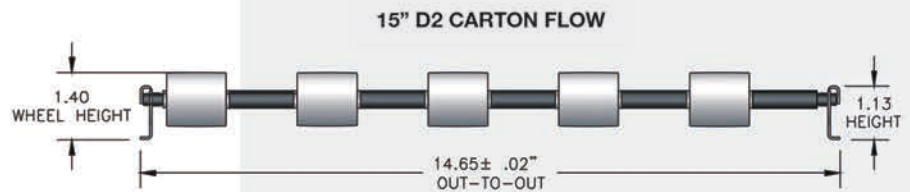
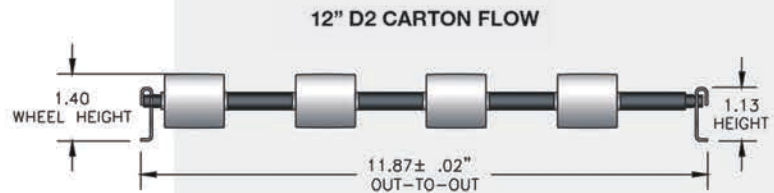

UPGRADE EXISTING SYSTEMS TO D2



Entry and exit brackets mount into carton flow shelf members with no loss of clearance and no labeling disruption.

RHINO TRAC™

FULL-WIDTH ROLLER CARTON FLOW TRACK

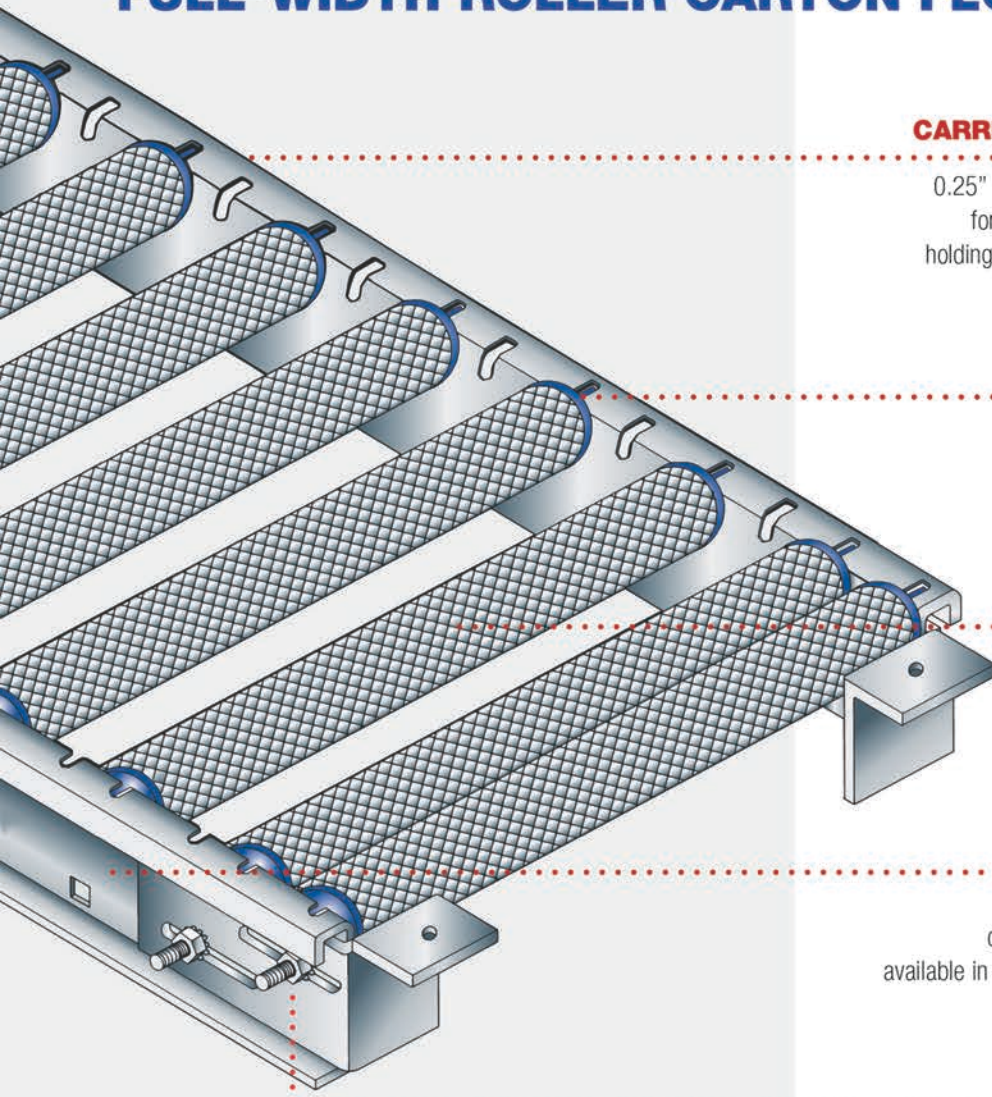

CARRIAGE BOLT TIE RODS

0.25" dia. carriage bolt tie rods allow for rapid roller replacement while holding side channels rigid and sturdy

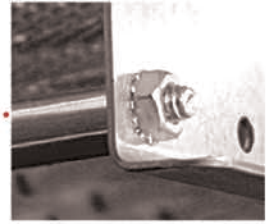

BUSHING

Superior bushing design

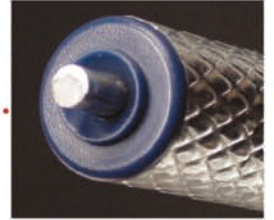

ROLLER

0.75" dia. aluminum diamond-embossed damage-resistant rollers with heavy-duty steel axes

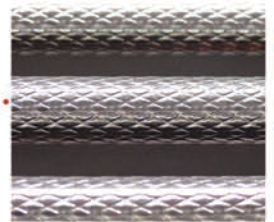

SIDE CHANNELS

2.5" high galvanized steel side channels for increased capacity available in 16 ga., 14 ga. and 12 ga. steel



TRACK SUPPORT

High-strength, integrated track supports adjust to assure proper fit



TRACK DIMENSIONS

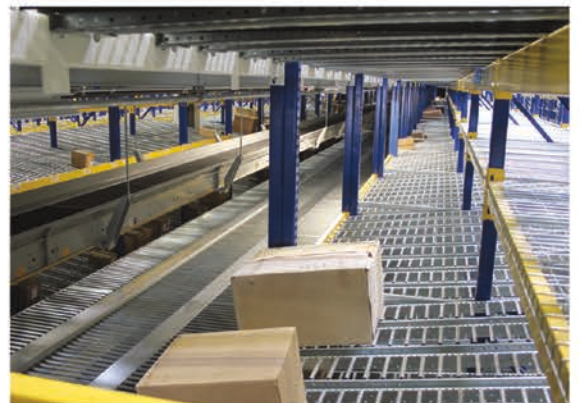
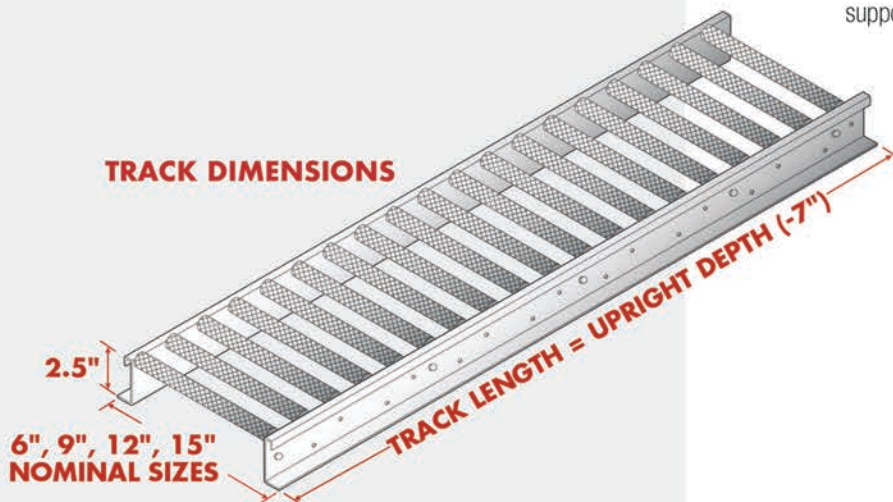

RhinoTrac pick module application - multi-level

RhinoTrac™ Heavy Duty SPECIFICATIONS

RHINOTRAC Roller Dimensions

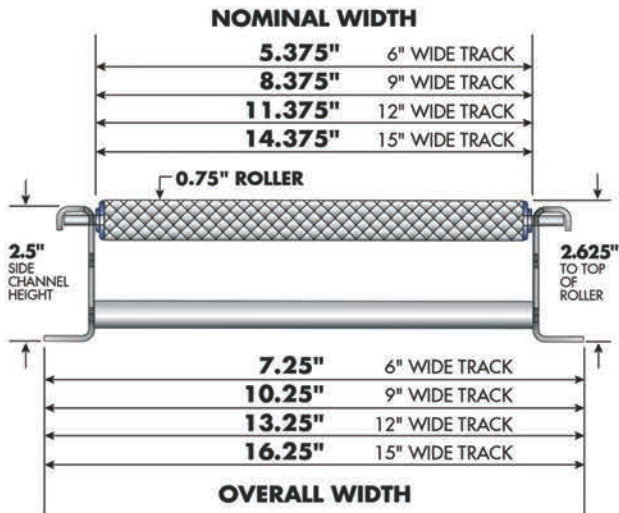

RHINOTRAC END SUPPORTS

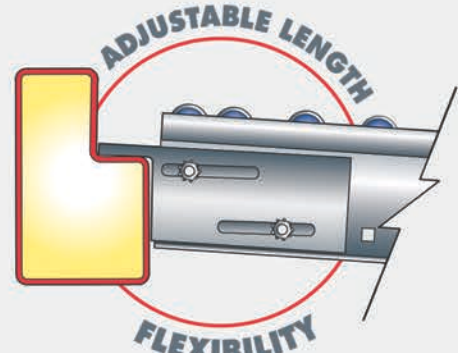

Roll-Formed Beam Bracket

EASY INSTALLATION

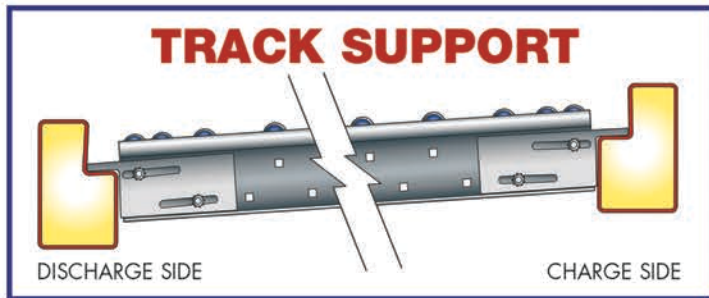

Slotted end supports adjust to vary length and ensure proper fit

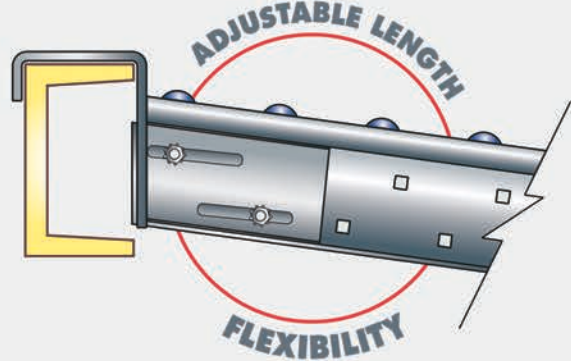

Structural Beam Bracket

Pre-installed heavy-duty steel end brackets allow for easy drop-in installation

Brackets directly support side channels and allow track to rest below the beam and use beam as end stop

Slotted adjustability of end supports allow the flexibility to vary length for field adjustment

Track Capacity Chart

TRACK CAPACITY SPAN PER FOOT*

TRACK SPAN	LBS. PER LIN. FT.	TRACK SPAN	LBS. PER LIN. FT.
60"	160.4	91"	45.2
63"	138.5	93"	43.1
66"	120.5	96"	39.2
69"	105.4	99"	35.7
72"	92.8	102"	32.6
75"	82.1	105"	29.9
78"	73.0	108"	27.5
81"	65.2	111"	25.3
84"	58.4	114"	23.4
87"	52.6	117"	21.6
90"	47.5	120"	20.0

Note: Track capacity may be limited by bracket capacity. Contact Springfield Engineering office for applications of more than 400 lbs/lane.

*Capacity based on L/240 deflection calculation

Track capacities shown for 16 gauge side channels. 14 gauge and 12 gauge available for heavier loads.



Integrated brackets with adjustability for structural beams



RhinoTrac brackets rest on beam ledge

RHINODECK™

DROP-IN CARTON FLOW SOLUTION

Slim profile carton flow to fit any carton flow shelving

Sturdy

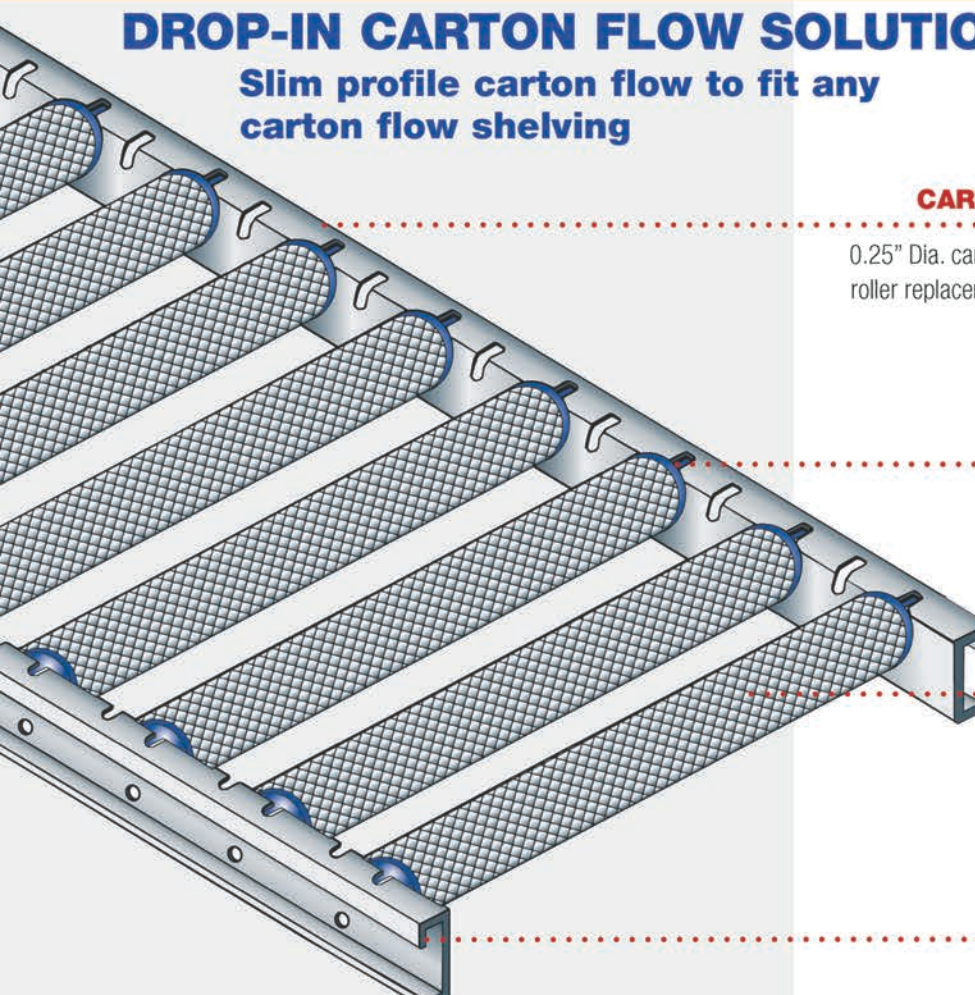

CARRIAGE BOLT TIE RODS

0.25" Dia. carriage bolt tie rods allow for rapid roller replacement while holding side channels rigid and sturdy



BUSHING

Superior bushing design



ROLLER

0.75" Dia. aluminum diamond-embossed damage-resistant rollers with heavy-duty steel axles

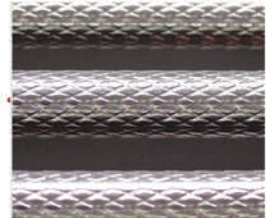

SIDE CHANNELS

1.1" High galvanized steel side channels



FLEXIBILITY & NO MAINTENANCE

- Low 1.1" profile
- Easily drops into existing carton flow systems
- Relocate tracks easily as SKU sizes change or your system grows

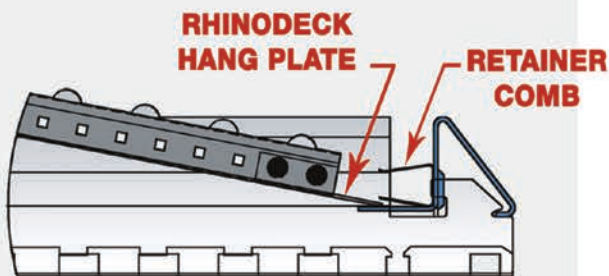

RhinoDeck installation for UPICK & KPICK carton flow

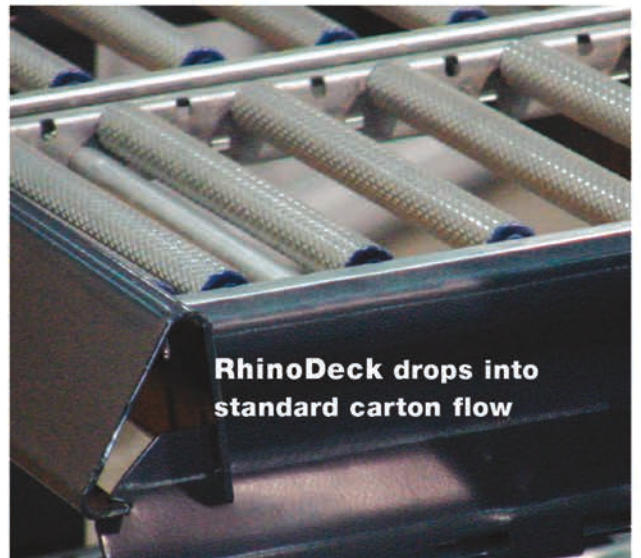

RhinoDeck drops into standard carton flow

RhinoDeck™ Low-Profile SPECIFICATIONS

Aluminum Full-Width Rollers

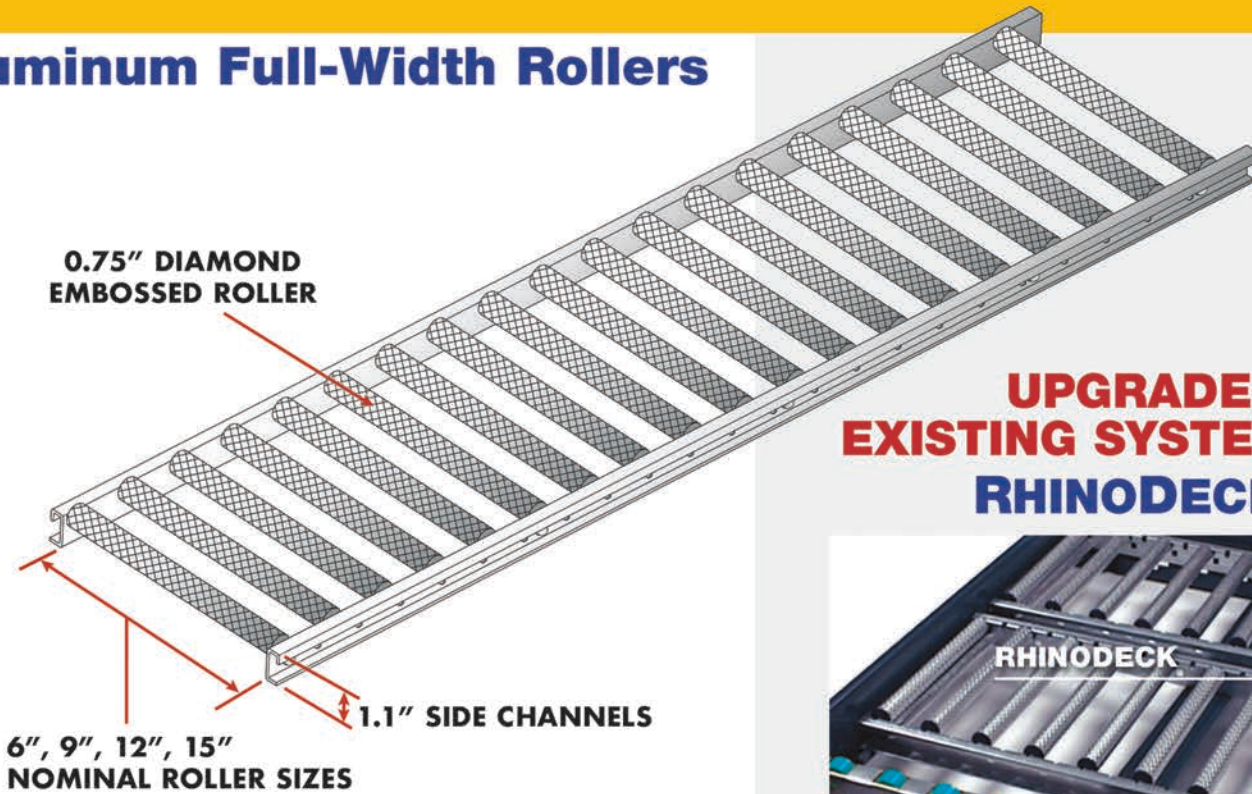

UPGRADE EXISTING SYSTEMS TO RHINODECK

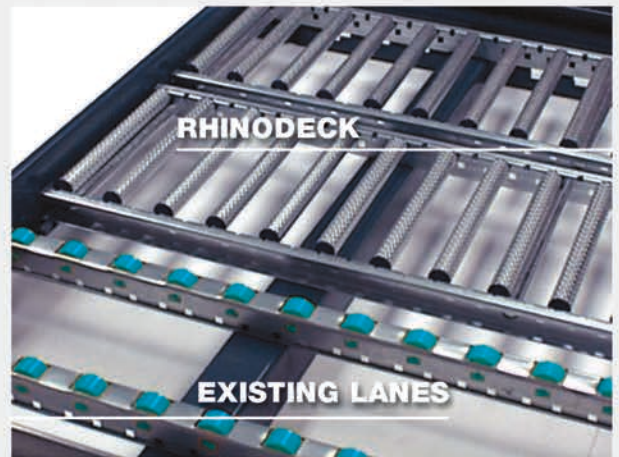

Replace existing damaged or poorly functioning carton flow lanes with RhinoDeck

RHINODECK Roller Dimensions

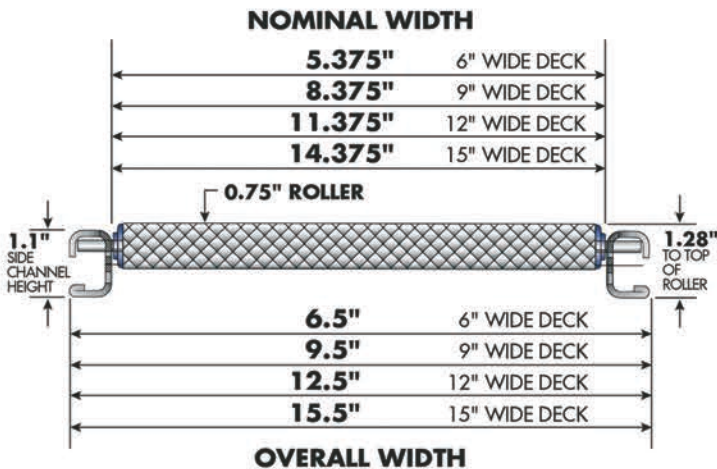

Impact Decks



RhinoDeck impact deck helps protect your carton flow rollers at high-impact drop areas.

NOTE: RhinoDeck lane capacity is generally limited by track support spacing. Track capacities exceed current carton flow tracks.

CONCENTRIC Carton Flow

FULL WIDTH ROLLER CARTON FLOW TRACK

Tilt Trays

Angle your product at pick point - Available for Dura-Flo or RhinoTrac

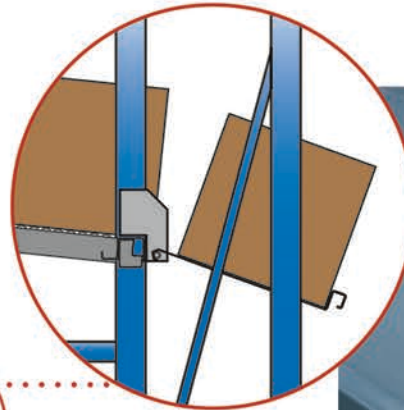
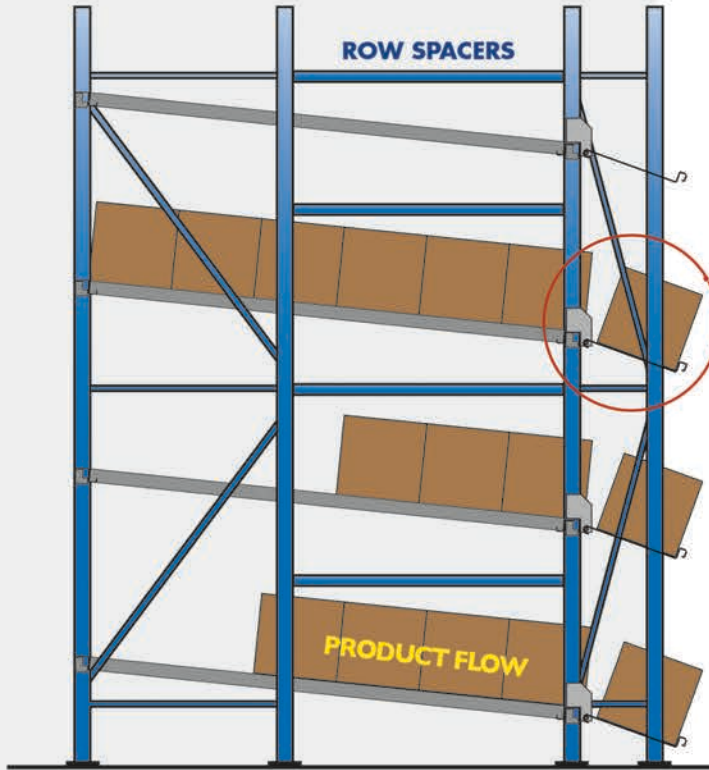

TILT TRAY DETAIL

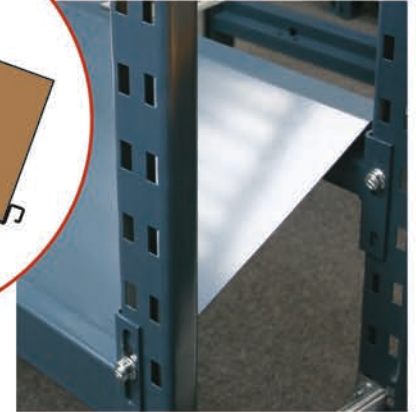

TILT TRAY BENEFITS

- **Product visibility**
Helps order picking accuracy
- **Layback version**
Every level is recessed from one below
- **Pick multiple levels with ease**
Never have to reach under shelf
- **More ergonomic for employees**
Less bending & reaching

RhinoTrac Knuckle Shelves

Angle rollers over beam to place product in proper picking position



INTERNAL KNUCKLE SHELF

EXTERNAL KNUCKLE SHELF

BOX STOP

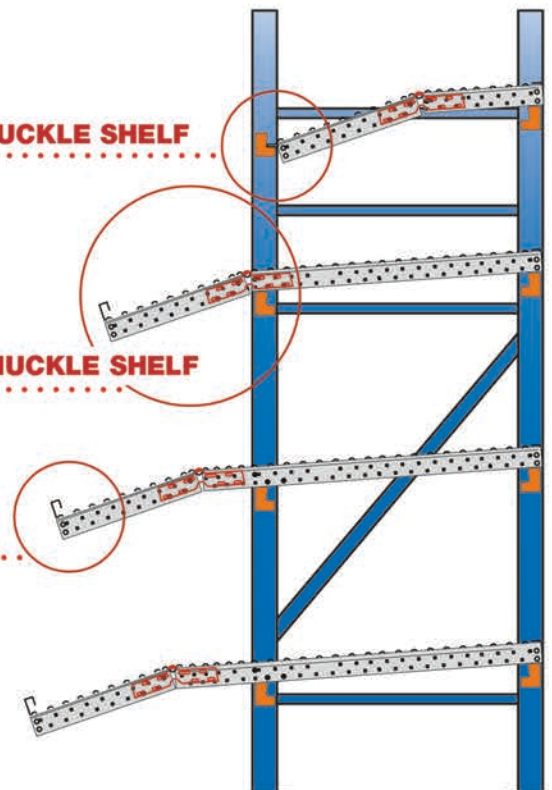

Cantilevered Shelf



RhinoTrac rear cantilevered shelf

Pick Modules



Multi-level RhinoTrac application

Full-Length Indexer



Keep boxes organized with lane defining index guides

Total Box Support



Full-width box support helps provide flow for damaged boxes.

RhinoTrac Deep Lane Splice Plates



LONGER LENGTHS

- Track-to-track splicing for extra deep lanes
- Splice plate attaches in field or factory

Deep Flow Lane



96" deep RhinoTrac lanes

PALLET FLOW



CSS Pallet Flow Wheel Options

SINGLE PLASTIC WHEEL

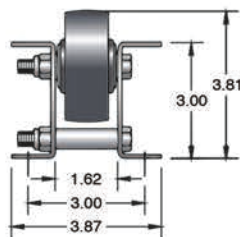

DOUBLE PLASTIC WHEEL

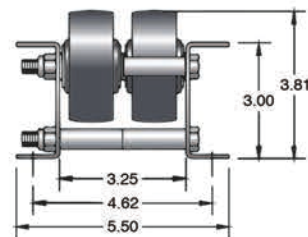

TRIPLE PLASTIC WHEEL

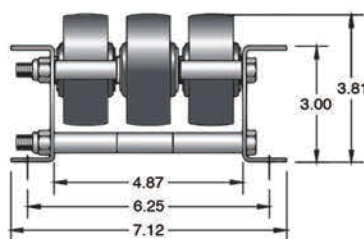

DOUBLE BRAKE WHEEL

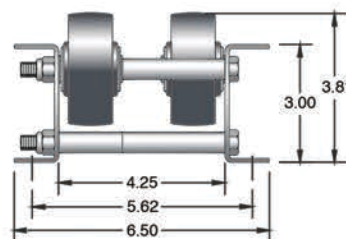

CSS PALLET FLOW

Optimize flow capabilities and provide efficient space utilization by eliminating unnecessary aisles

- Provides greater inventory control
- Automatic stock rotation
- Reduce labor and equipment costs
- Allow for future growth
- Increase storage space from 30% to 100%
- Limit product damage and spoilage
- Improve product turnaround time
- Increase overall productivity

SINGLE METAL SKATE WHEEL

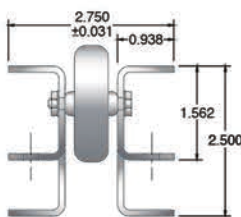

DOUBLE METAL SKATE WHEEL

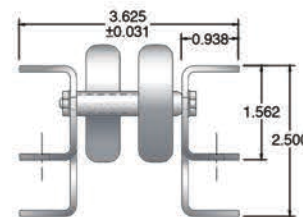

Plastic Wheels



Plastic wheels are manufactured from specially engineered resins for high-impact, high-strength and have been rigorously tested for maximum performance in your specific warehouse environment. Available with sealed bearings for cooler conditions.

Metal Wheels

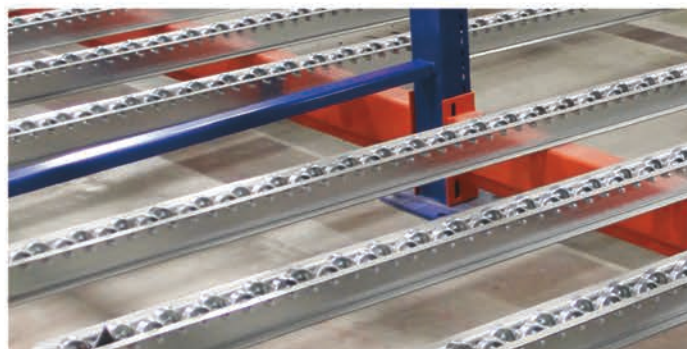

Zinc-plated metal wheels for lighter load picking applications are available with in-line or staggered configurations.

Pallet Flow SPECIFICATIONS

Pallet Flow Track Comparison

	Description	Application	Load Capacity	Characteristics
	Plastic Wheel Track <i>Moderate to heavy pallet flow</i>	For industrial production and distribution pallet storage environments.	500 to 5,000 lbs.	Wheel patterns can be designed inline or staggered on 2", 3" or 4" centers. Bearingless and bearing 2.87" diameter plastic wheels.
	Brake Track <i>Moderate to heavy pallet flow</i>	Used in moderate to heavy pallet flow applications for industrial production and distribution pallet storage environments.	1,000 to 5,000 lbs.	Patented cantilever-designed for superior pallet support, track allows for variety of pallets to flow, including GMA, Plastic, Euro, Slave and boxes. Wheel pattern can be designed inline or staggered on 2", 3" or 4" center configurations. Can be used in double and triple configurations for heavier pallets.
	Wide Steel Roller <i>Light to heavy pallet flow</i>	Used in applications where pallets have inconsistent bottom surface, plastic pallets and where bottom runners are parallel to direction of flow.	Up to 5,000 lbs.	Split-rail systems and full-width systems available depending on requirements. 1.9" diameter galvanized steel rollers.

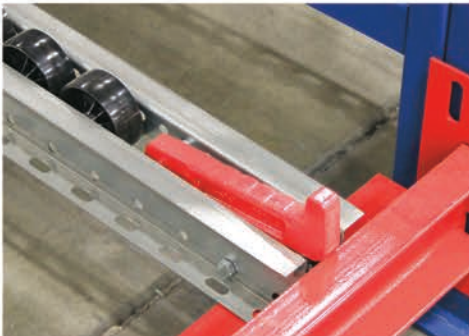

Solid metal pallet stops are integrated into every lane.

STRUCTURAL OR ROLL-FORMED PALLET RACK

Plastic wheel pallet flow rails rest on angle of structural beam or in the step of roll-formed beam for low-profile storage with maximum vertical space.



Metal skate wheel rails are notched to fit into the step of pallet rack beams.

Pallet Flow Specifications



Wheels	Application	Load Capacity	Dia.	Width	Characteristics
Bearingless Plastic Wheel <i>Light flow applications</i>	<ul style="list-style-type: none"> • Pick modules • Wash-down environments • Heavy impact areas 	580 lbs. per wheel	2.87"	1.375"	Material: Polycarbonate alloy resin; reinforced rib design; high-strength and significant impact resistance.
Bearing Plastic Wheel Standard or Sealed <i>Moderate to heavy flow</i>	<ul style="list-style-type: none"> • FIFO deep lane • Push back • Pick modules • Empty return lanes 	320 lbs. per wheel	2.87"	1.375"	Material: Polycarbonate alloy resin; specially engineered resins; reinforced rib design; two bearings provide excellent rolling characteristics; sealed bearing where environment is a concern.
Aluminum Wheel Optional Impact Zone Wheel	<ul style="list-style-type: none"> • 1st and last pallet position in forklift load / unload zones • Heavy impact areas 	320 lbs. per wheel	2.87"	1.125"	Material: Aluminum high-strength wheel; two bearings provide excellent rolling characteristics; high-strength and significant impact resistance.
Metal Skate Wheel Light-Duty Wheel for light loads in picking applications	<ul style="list-style-type: none"> • Picking applications (2-3 deep) • Light loads with lower risk of pallet hang-ups • Empty return lanes 	100 lbs. per wheel	1.9"	0.5"	Material: Zinc plated steel. Light-duty wheel with lower capacity. Ball bearings provide low-friction rolling characteristics.

PALLET FLOW

WIDE-ROLLER



Full-width rollers provide total pallet support throughout flow lane (shown with pallet entry guides)

Steel Rollers

Roller configurations available on 2", 3" or 4" centers and up to 52" wide to help support even the most inconsistent pallets.

Gravity steel roller systems function in most environments, even temperatures down to -40° F. Rollers are available in galvanized or oil finish and provide an excellent rolling surface for:

- Plastic pallets
- Skids
- Wire baskets
- Slip sheets
- Corrugated skids
- Plastic returnable shipping containers
- Odd size pallets
- Pallets with bottom runners parallel to direction of flow

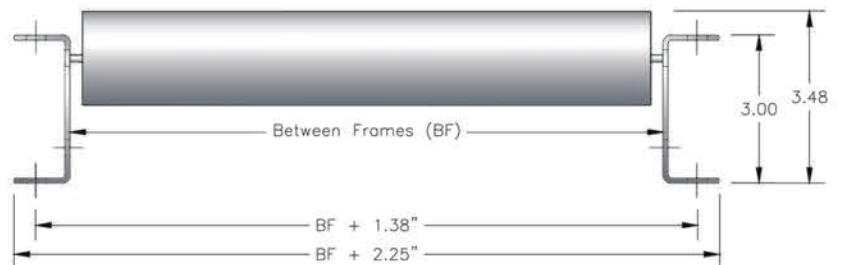

Factory-installed brakes are used for speed control in deep lane wide-roller systems.

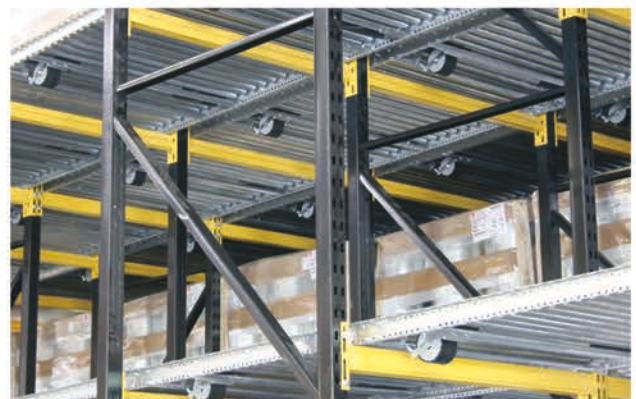

Pallet Flow Specifications

Wheels	Application	Load Capacity	Dia.	Characteristics
Steel Roller	<ul style="list-style-type: none"> • FIFO • LIFO systems • Plastic/multiple pallets or slip sheets 	270 lbs. per roller	1.9"	Widths: 4.25 to 52 inches, full-width or split-rail roller systems in 12 to 16 gauge galvanized steel. Sealed bearings are optional.

Pallet Flow BRAKING

Brakes and Brake Tracks

Speed controllers are manufactured from high-strength, glass-reinforced engineered resins with molded-in metal reinforcements in all high-stress areas. Permanently lubricated with a special high/low temperature lubricant, ensures speed controllers require no further maintenance.

- Factory installed in ALL tracks
- Patented cantilever wheel support design
- Specially engineered resin wheels
- Additional load support in the braking zone

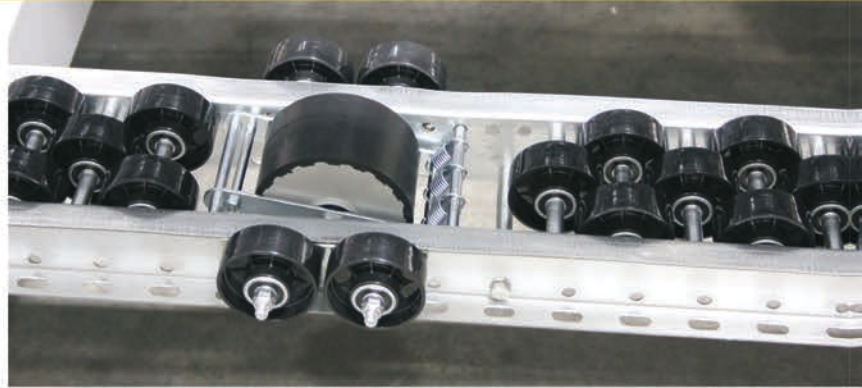

Engineered Pallet Speed Control

Concentric Storage Systems provides application analysis, engineering, testing, and expert installation.

Speed controllers specifically engineered for your pallet size and weight.

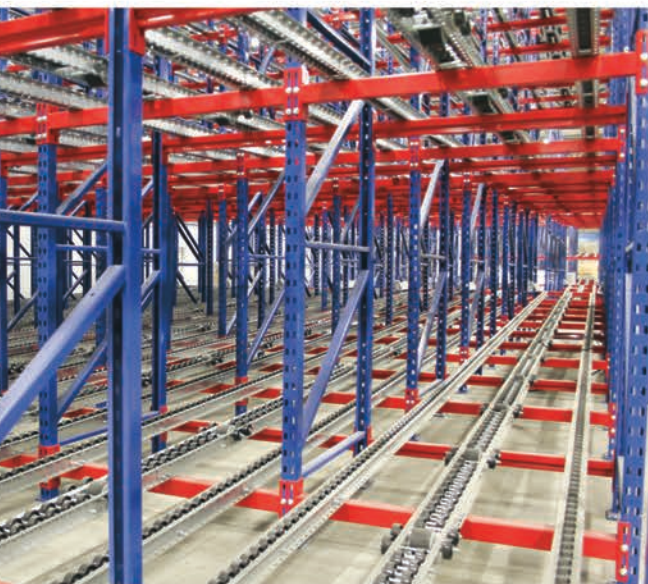

Deep lane systems maximize warehouse space by eliminating aisles and creating dense pallet storage. Concentric braking and speed control mechanisms keep your pallets flowing safely and minimize product damage.

Pallet Flow Brake Specifications

Wheels	Application	Characteristics
 <p>Speed Controller/Brake <i>Light, moderate and heavy flow</i></p>	<p>Provides speed control in steel roller and plastic wheel pallet flow systems.</p>	<p>Centrifugal brake plate, rotated by a two-stage planetary gear mechanism. Outer hub features a polyurethane over mold that provides high friction contact with the pallet. Inner brake construction from engineered high-strength resins and galvanized metal to ensure maintenance-free, maximum durability and long service life.</p>

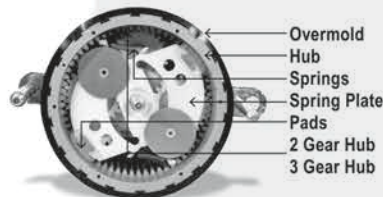
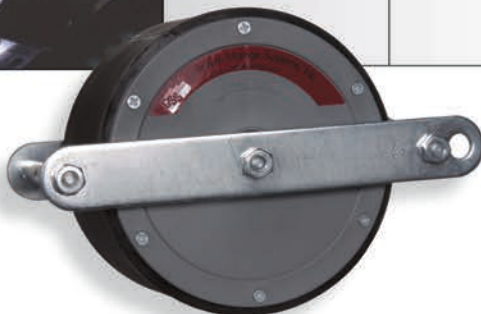

**Innovative carton flow and
pallet flow ideas to increase
warehouse efficiency.**

**More storage flexibility and
less maintenance.**



CONCENTRIC STORAGE SYSTEMS, INC.

3438 Briley Park Blvd N
Nashville, TN 37207

www.concentricstorage.com

PHONE 1-800-649-4428